

DSC WMBAS C

DESCENT Tap Range Descent Wall Mounted Basin Mixer Chrome

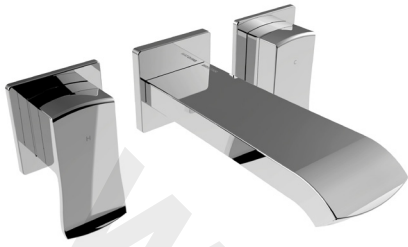

Features:

- Long life and easy to use 1/4 turn ceramic disc valves
- 1/2" Valve
- Brass construction

Product Certifications:



For more products, visit our website:
<http://www.bristan.com>



Specification

Product Type:	Bathroom Taps
Main Construction Material:	Brass
Mount Type:	Wall Mounted
Handle Type:	Lever Handles
Connection Inlet:	15mm Compression Threaded Tail
Connection Outlet:	M24 Anti-Splash
Number of Tap Holes:	3
Valve/Cartridge Type:	1/2" Ceramic Disc Valve
Plumbing System Requirements:	Suitable for all plumbing systems
Minimum Dynamic Pressure (bar):	0.2 bar
Maximum Dynamic Pressure (bar):	5.0 bar
Maximum Hot Water Temperature °C:	60°C
Maximum Static Pressure (bar):	10 bar
Flow Type:	Single Flow
Isolation Included:	No

Dimensions (measurements in mm)

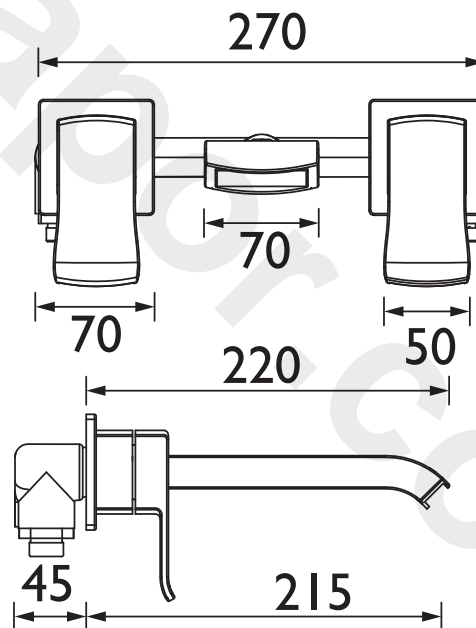

Flow Rates (l/min)

System Pressure (bar)	0.2	0.5	1	2	3	5
DSC WMBAS C (mixed)	9.9	15.7	22.2	31.4	38.4	49.6

TECHNICAL DATA SHEET



BRISTAN

D3